

TABLE OF CONTENTS

3D VIEW WITH TYPICAL DETAILS _____	02
TYPICAL PLAN DETAILS _____	03
TYPICAL PLAN DETAILS (VENTS) _____	05
TYPICAL CORNER DETAILS _____	07
TYPICAL SPANDREL PLAN DETAIL _____	09
TYPICAL BYPASS DETAIL _____	09
TYPICAL SECTION DETAILS _____	11
TYPICAL SECTION DETAILS (VENTS) _____	13
TYPICAL DETAILS AT BALCONY _____	16
PARTS LIST _____	18

KEY FEATURES:

- 5 $\frac{7}{8}$ " mullion depths
- Custom depths available upon request
- Stick-built system
- Dry glaze
- Standard 1" infill
- $\frac{1}{4}$ " infill with adaptors
- 1 $\frac{3}{4}$ " triple IGU infill



STADIA INDUSTRIES LTD.

20 Bessemer Court Concord, Ontario Canada L4K 3C9
Phone: (905) 761-9639 Fax: (905) 761-1268

JANUARY 2023

1000 WINDOW WALL SERIES

3D VIEW WITH TYPICAL DETAILS

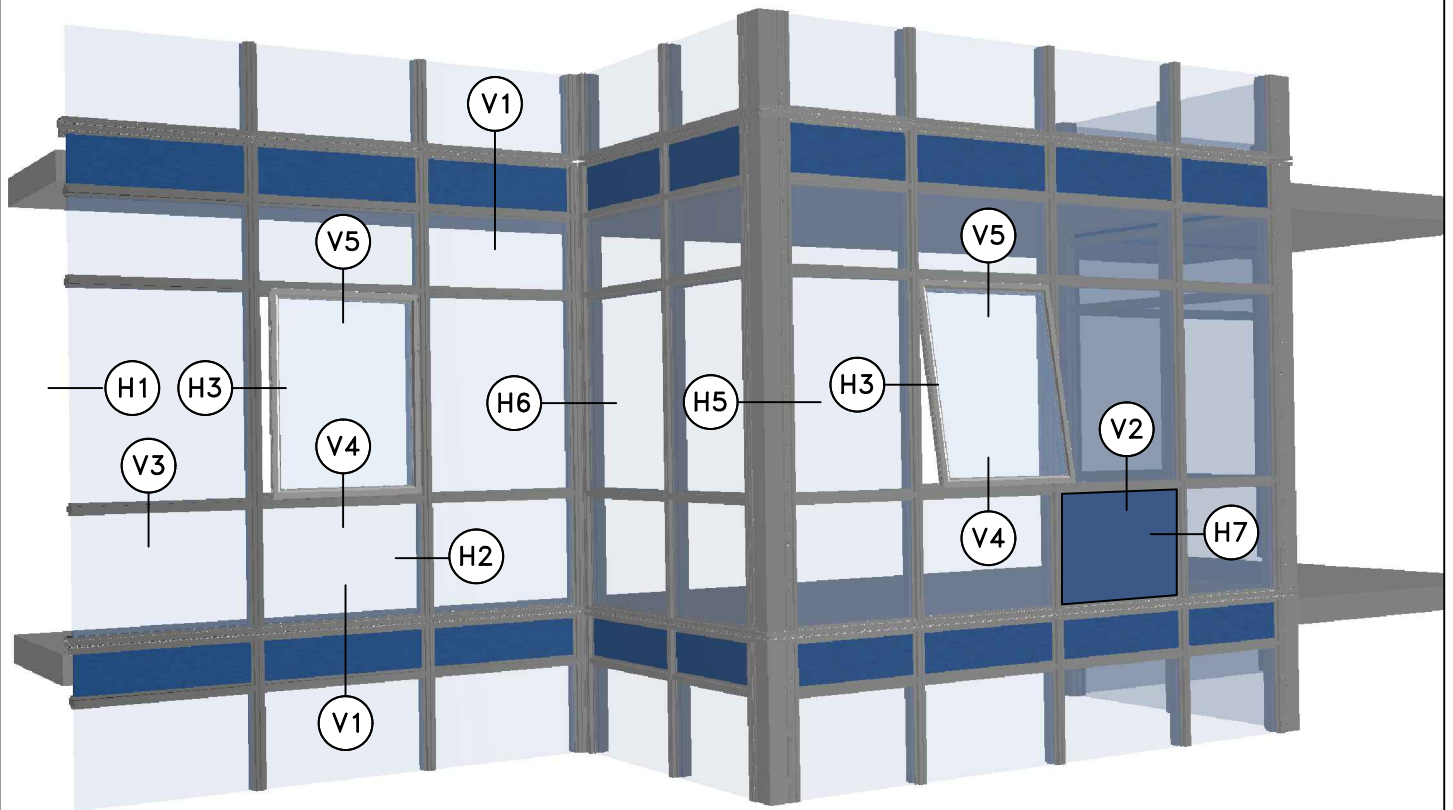

1000 WINDOW WALL SERIES

TYPICAL DETAILS

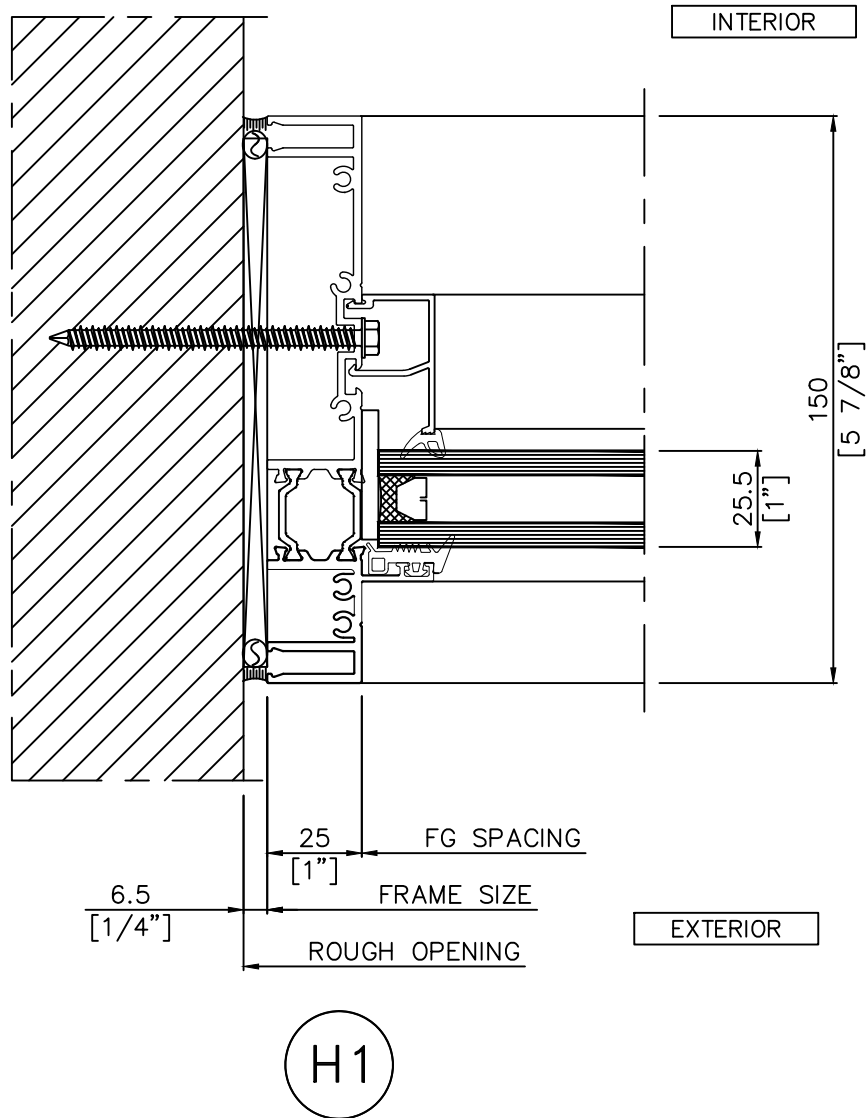

1000 WINDOW WALL SERIES

PAGE03A

TYPICAL DETAILS TRIPLE GLASS OPTION

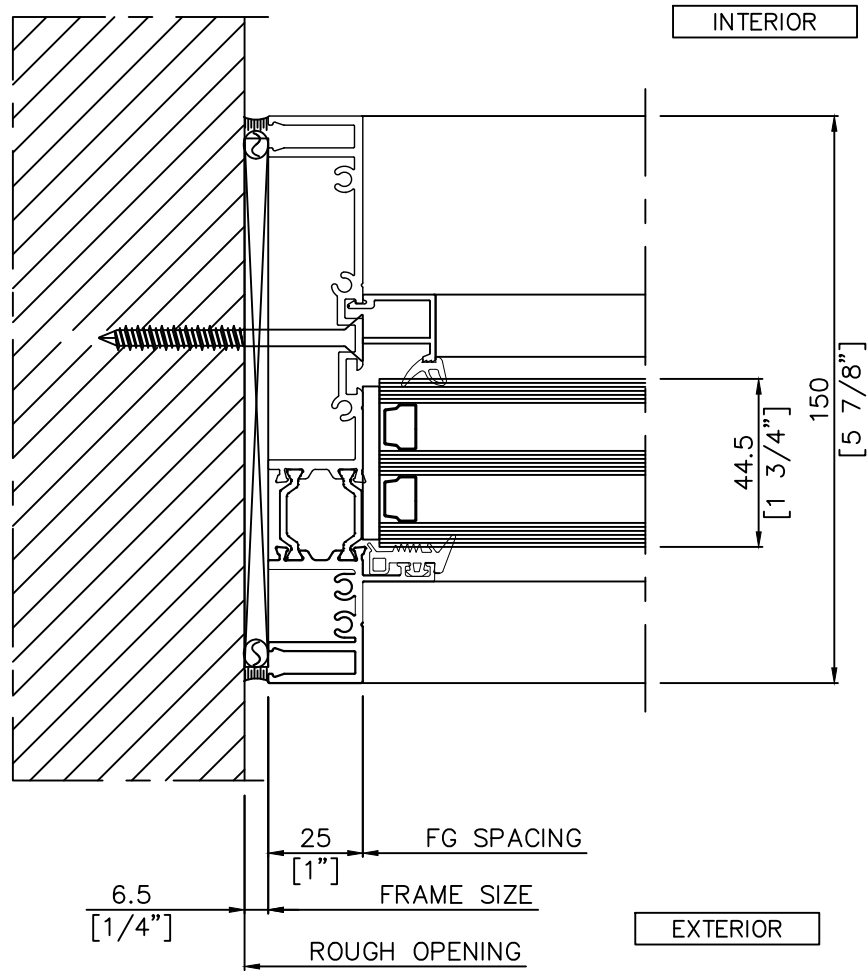

H1A



STADIA INDUSTRIES LTD.
20 Bessemer Court Concord, Ontario Canada L4K 3C9
Phone: (905) 761-9639 Fax: (905) 761-1268

JANUARY 2023

1000 WINDOW WALL SERIES

TYPICAL DETAILS

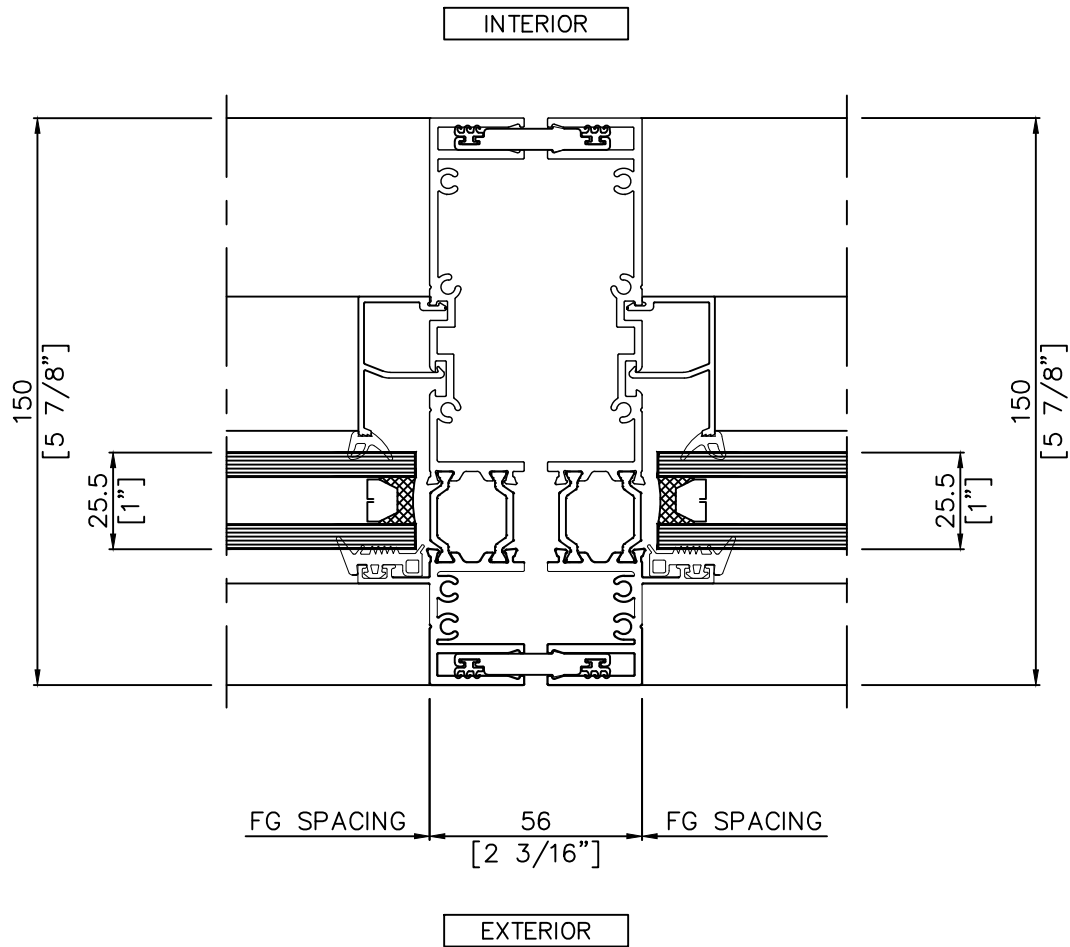

H2



STADIA INDUSTRIES LTD.
20 Bessemer Court Concord, Ontario Canada L4K 3C9
Phone: (905) 761-9639 Fax: (905) 761-1268

1000 WINDOW WALL SERIES

TYPICAL DETAILS

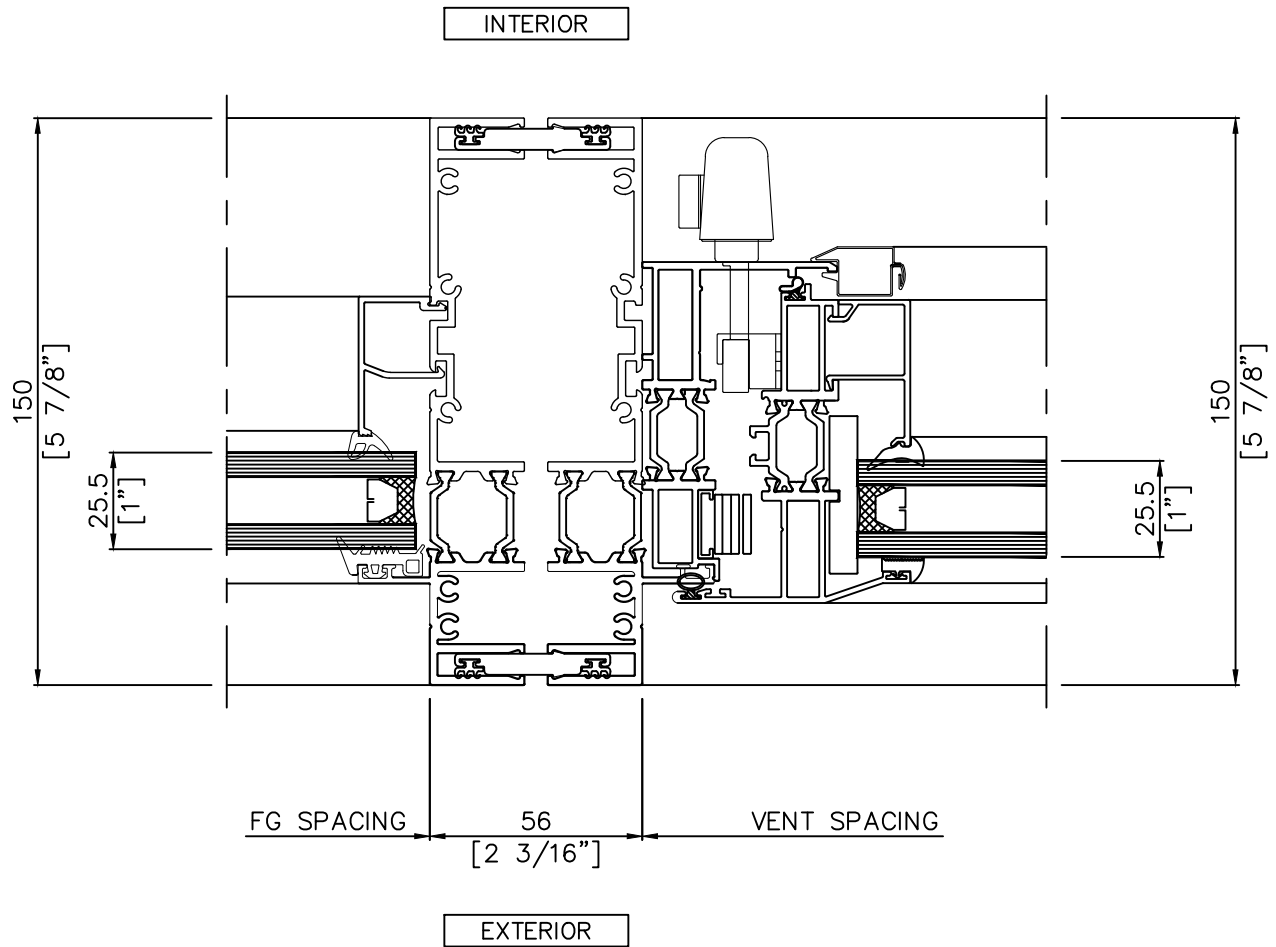

H3

1000 WINDOW WALL SERIES

TYPICAL DETAILS

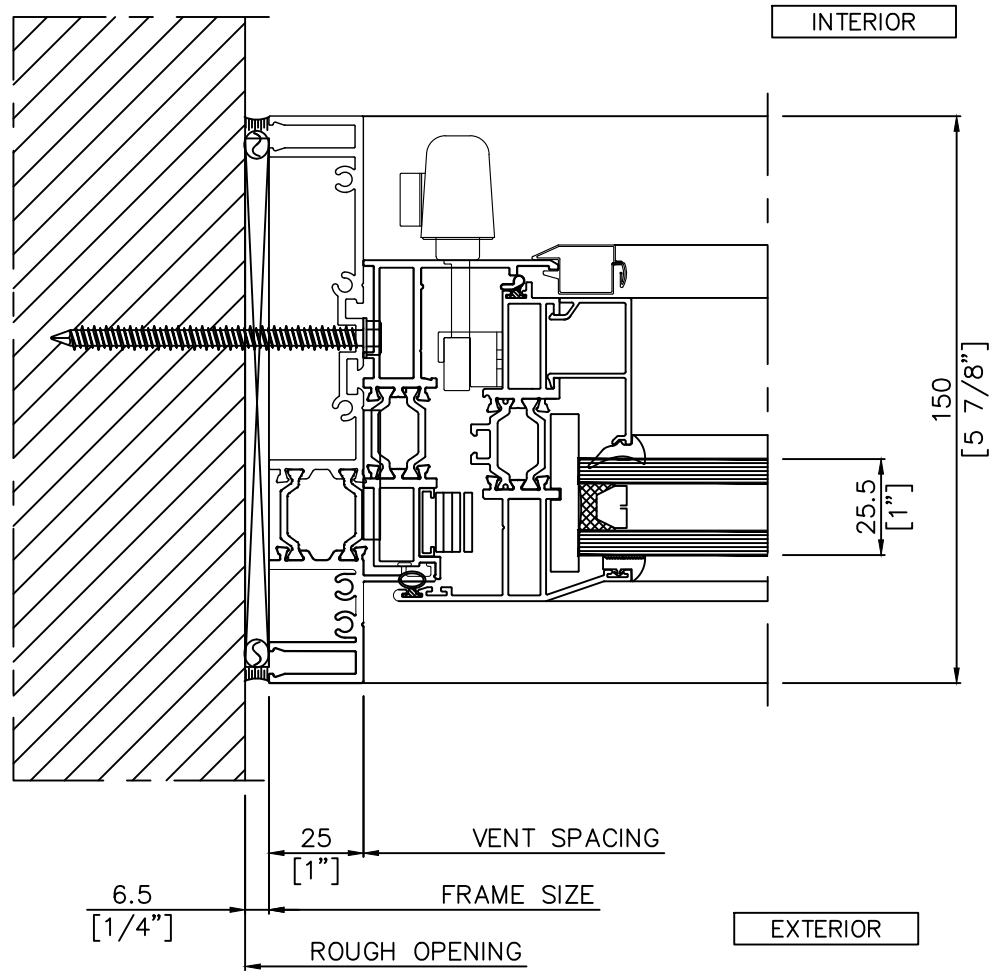

H4

1000 WINDOW WALL SERIES

TYPICAL DETAILS

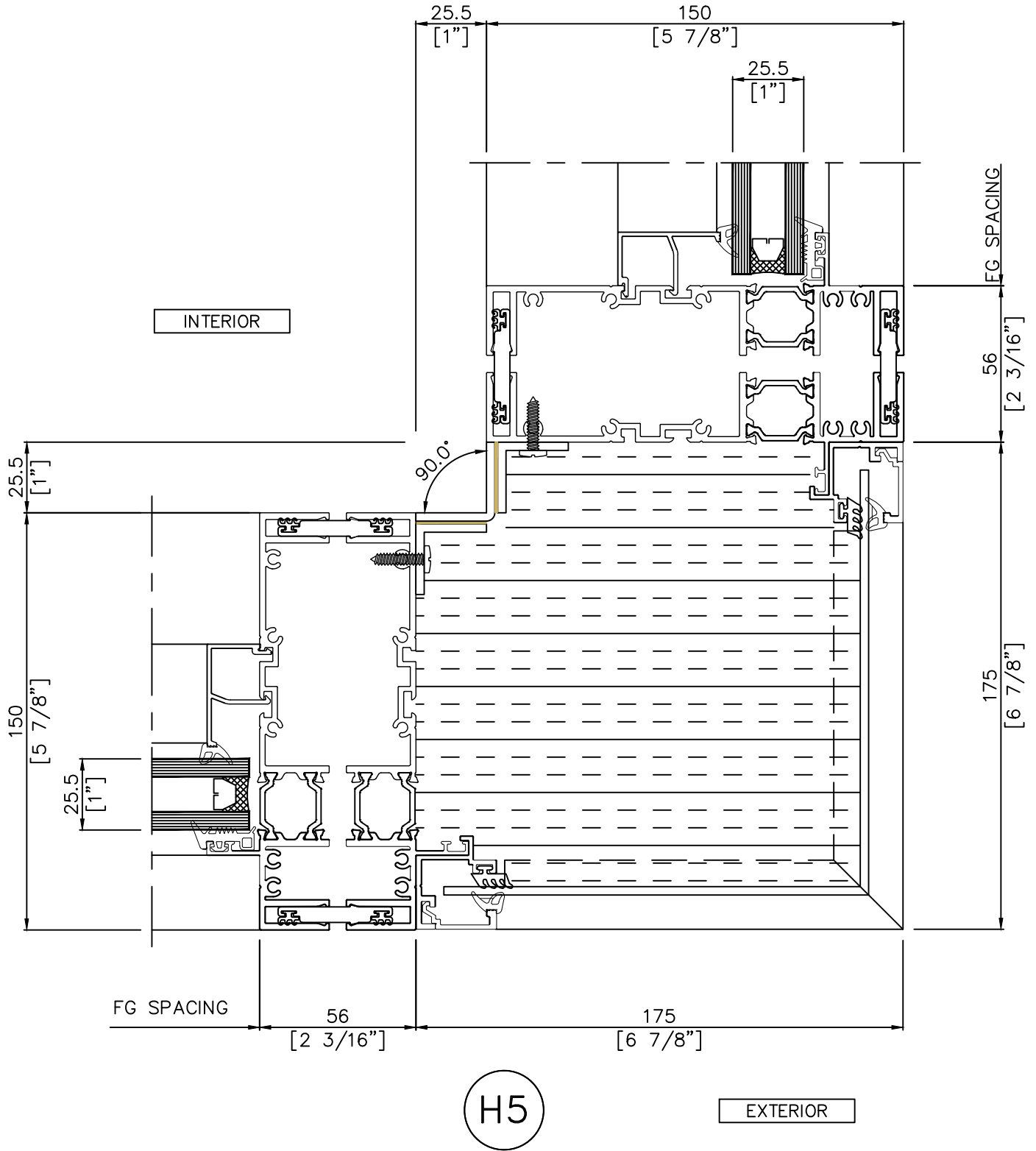

1000 WINDOW WALL SERIES

TYPICAL DETAILS

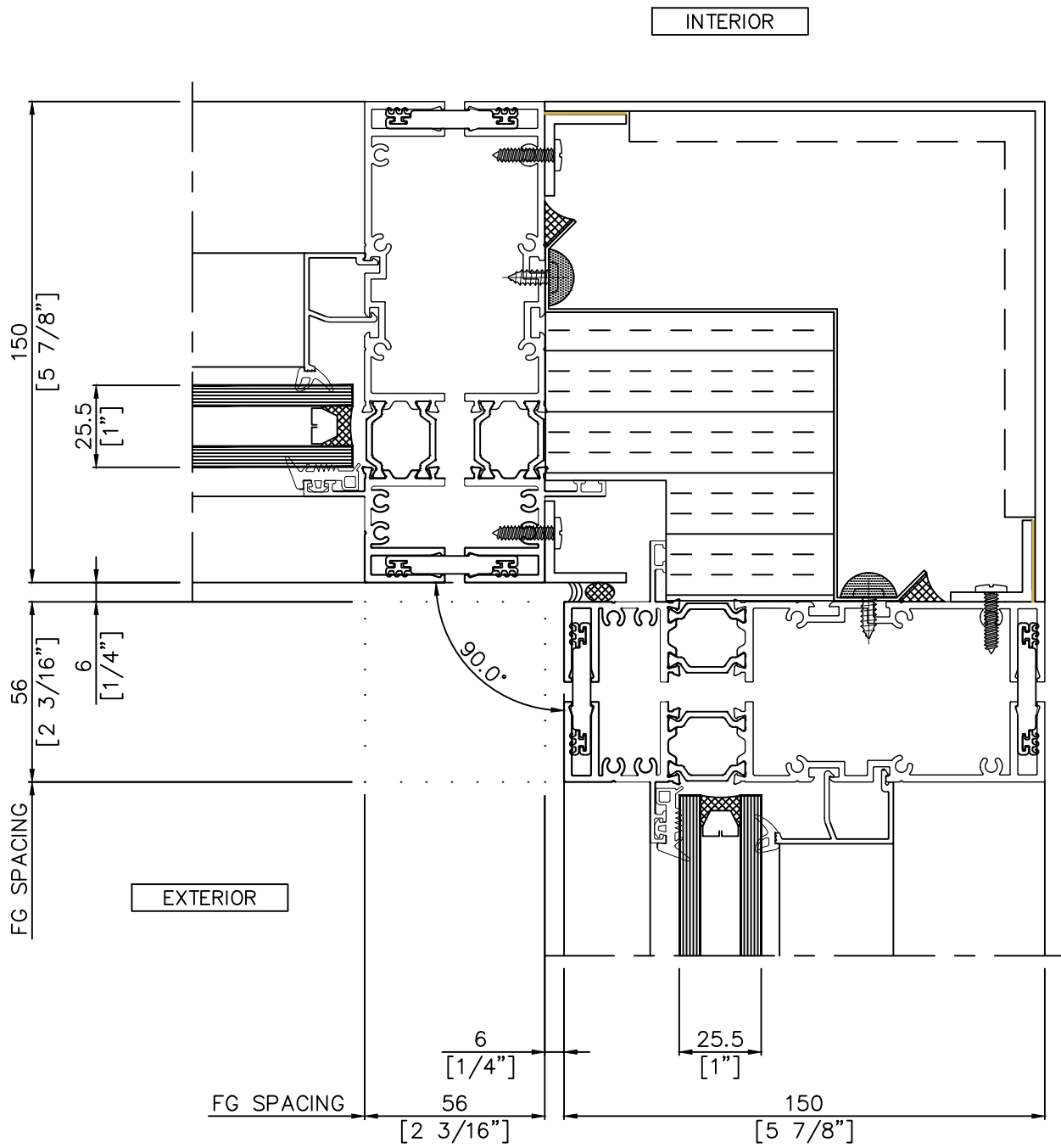

H6



STADIA INDUSTRIES LTD.
 20 Bessemer Court Concord, Ontario Canada L4K 3C9
 Phone: (905) 761-9639 Fax: (905) 761-1268

1000 WINDOW WALL SERIES

TYPICAL DETAILS

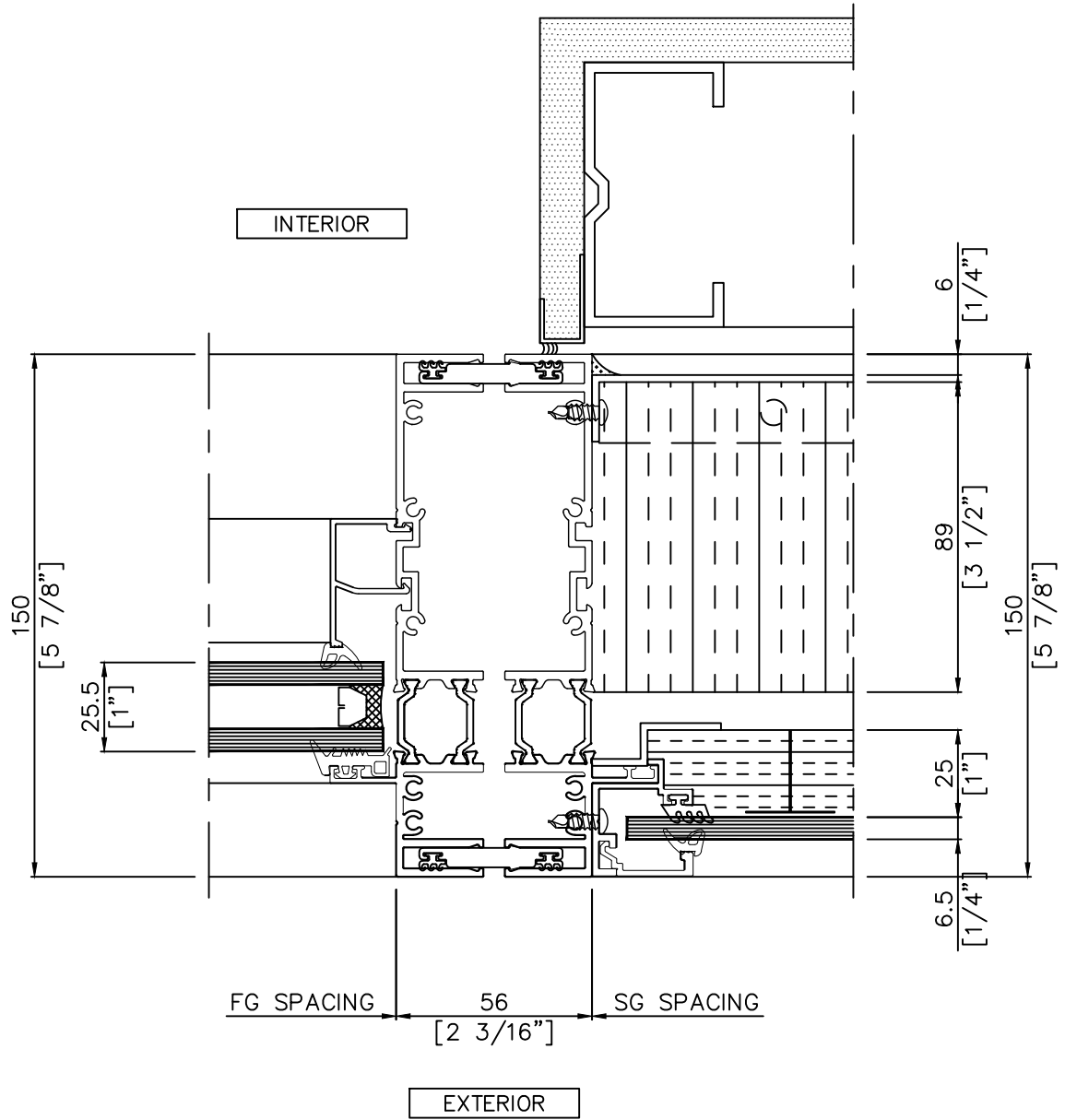

H7

1000 WINDOW WALL SERIES

TYPICAL DETAILS

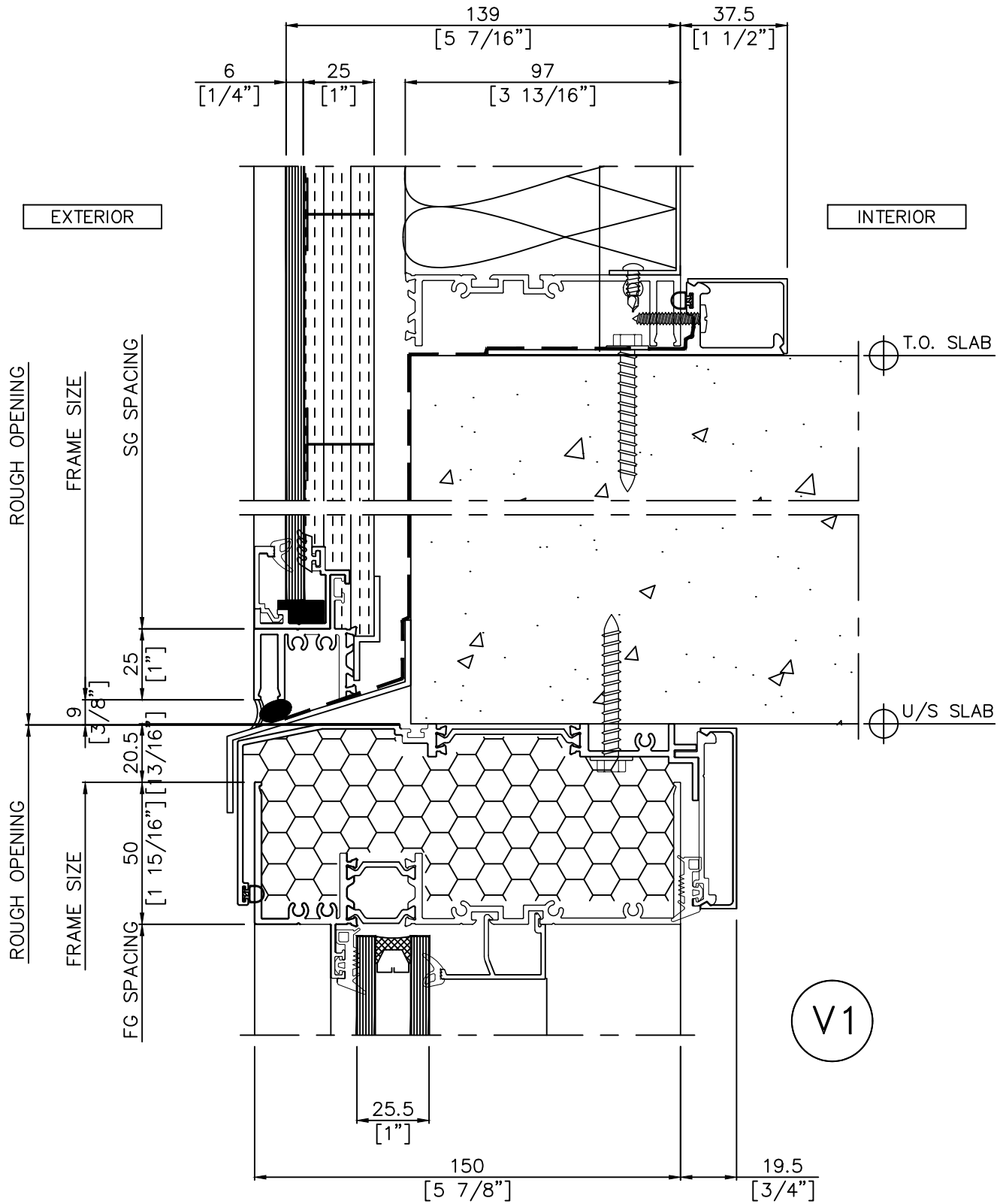

1000 WINDOW WALL SERIES

TYPICAL DETAILS

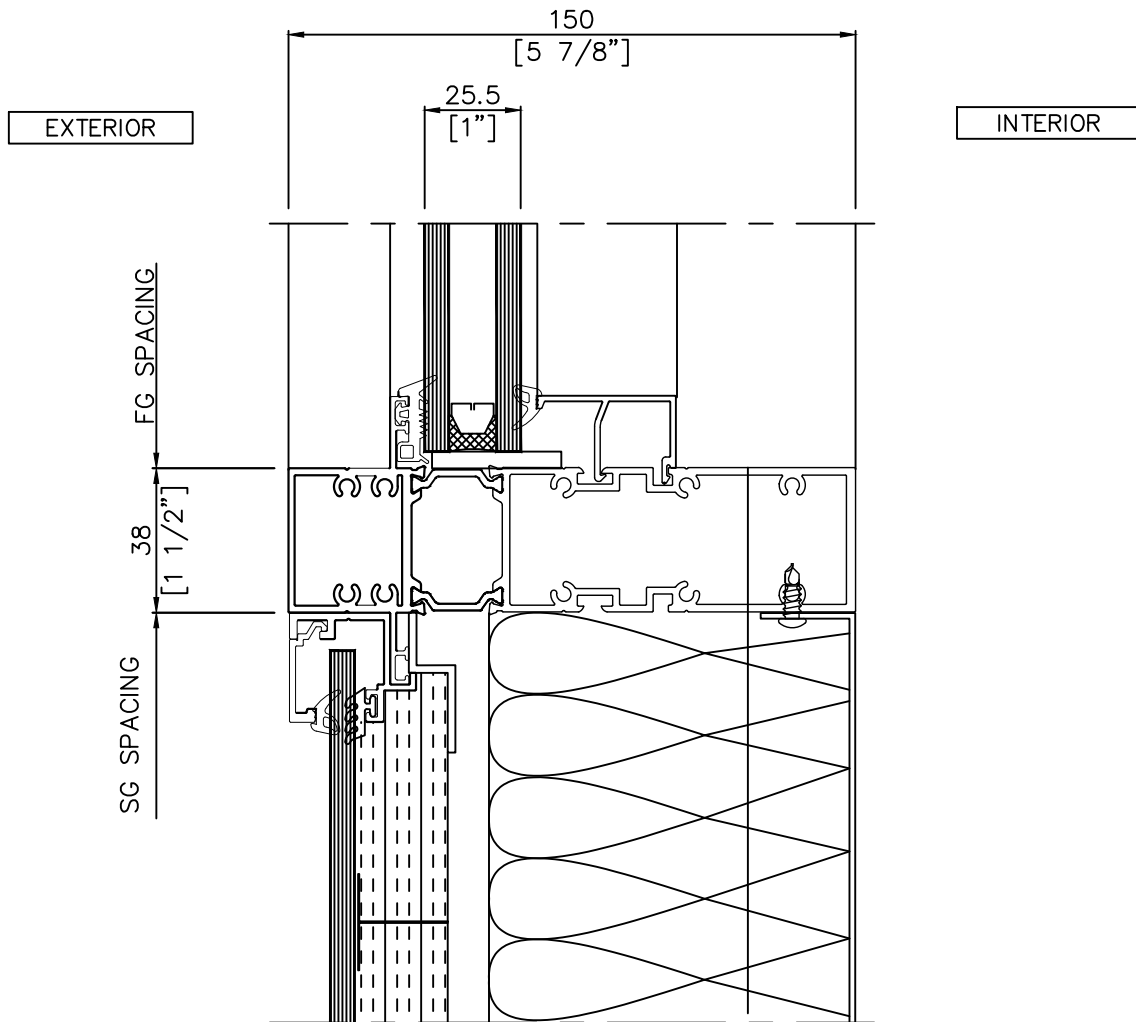

V2

1000 WINDOW WALL SERIES

TYPICAL DETAILS

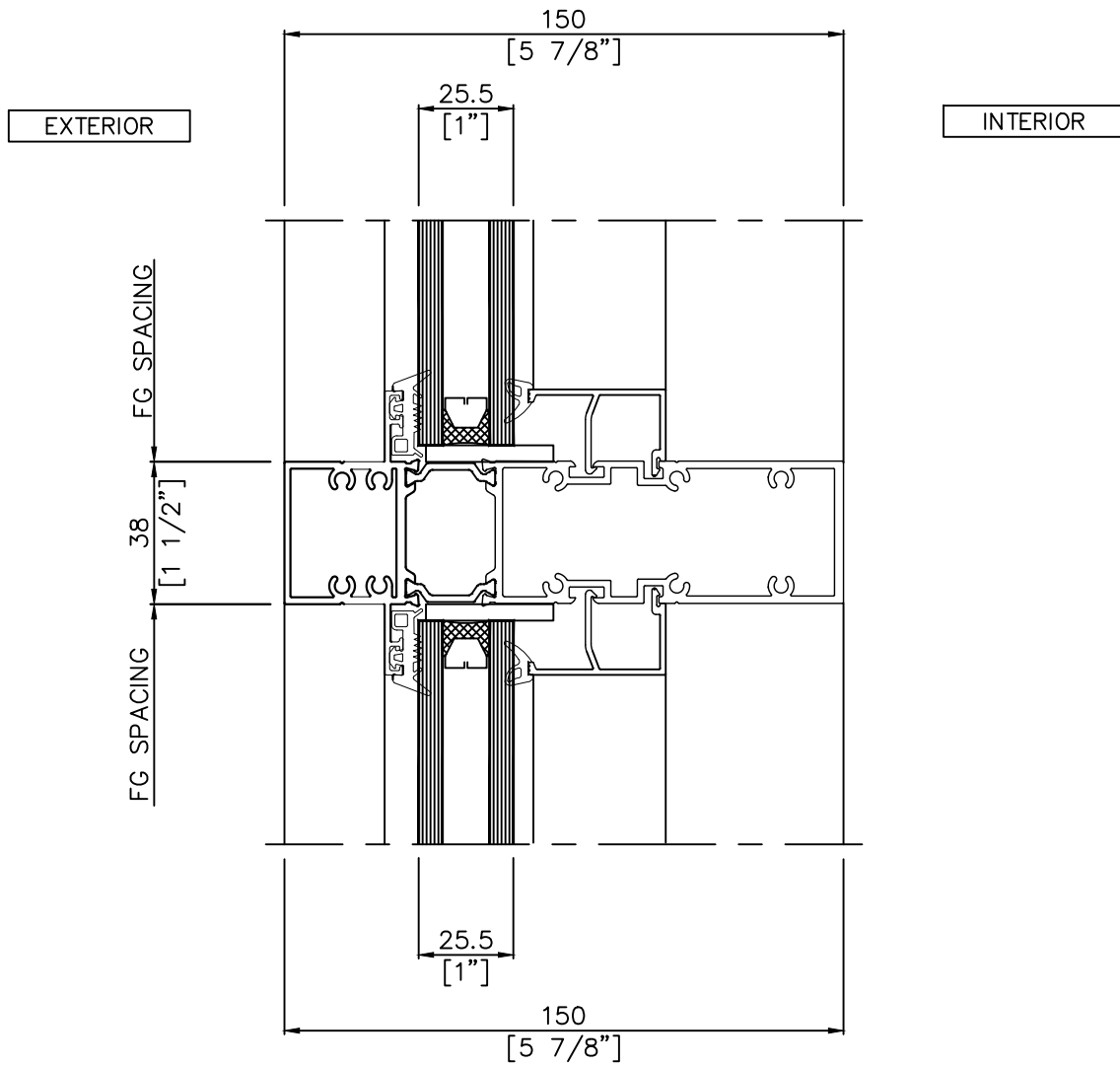

V3

1000 WINDOW WALL SERIES

TYPICAL DETAILS

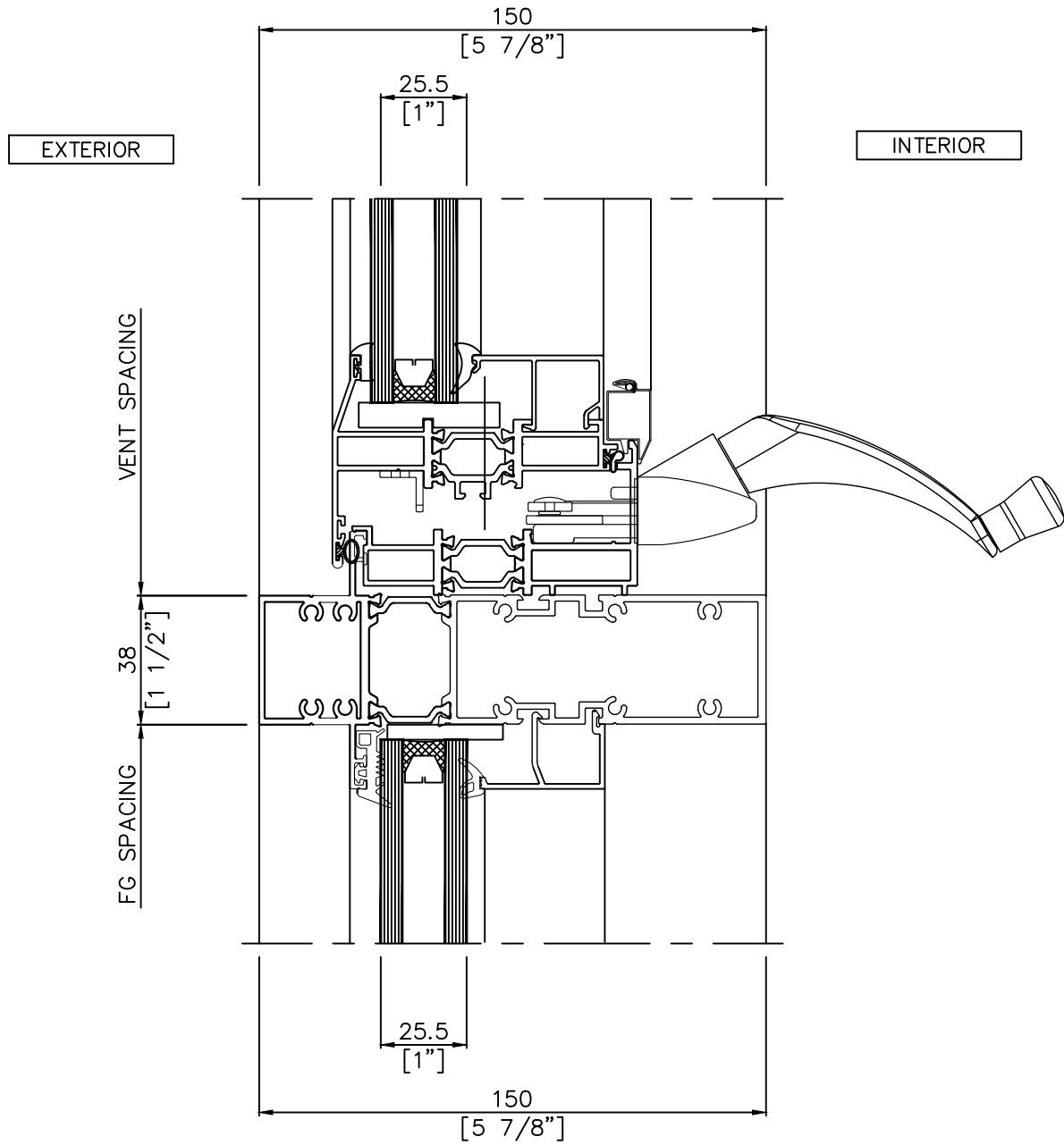

V4

1000 WINDOW WALL SERIES

TYPICAL DETAILS

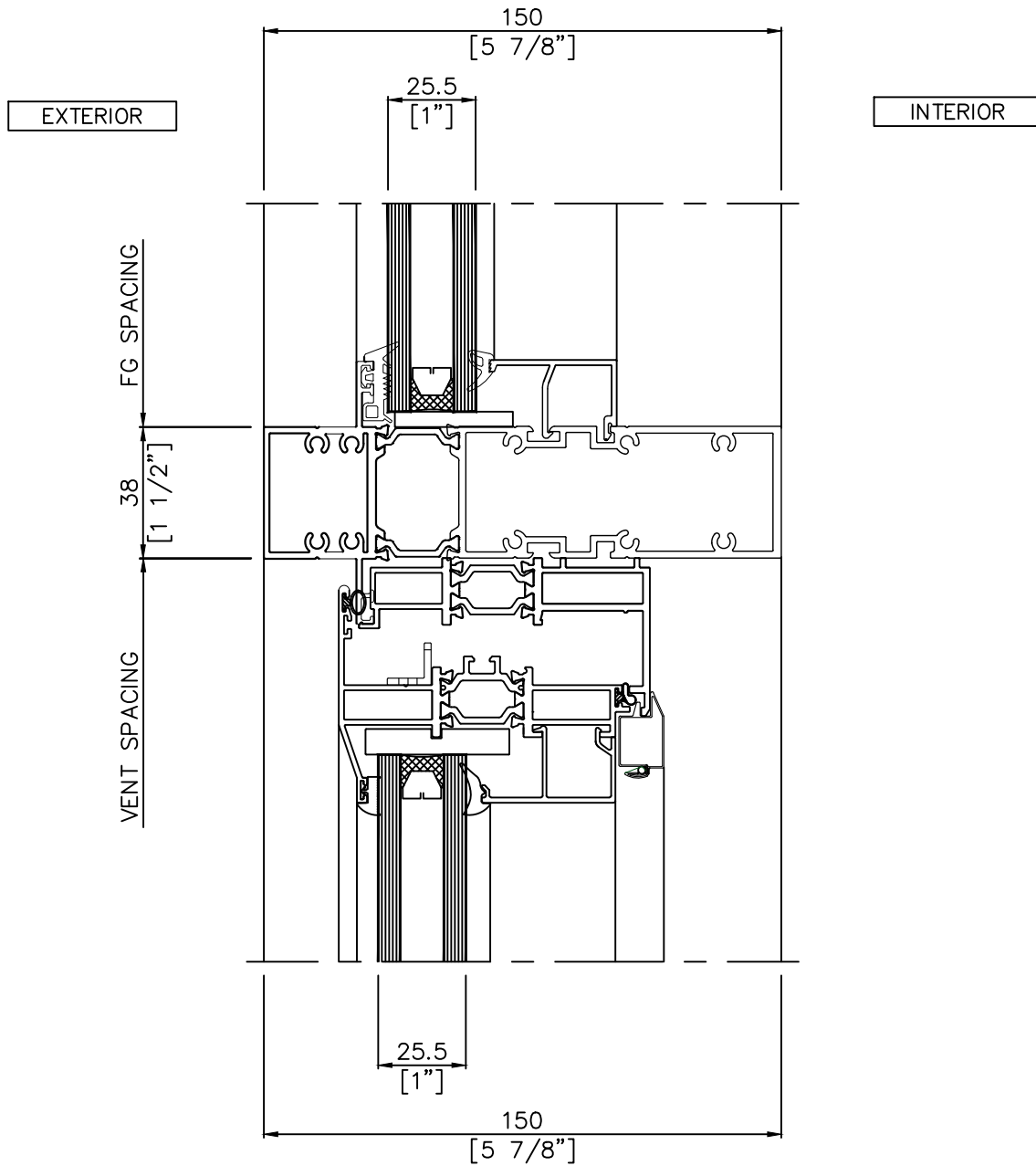

V5

1000 WINDOW WALL SERIES

TYPICAL DETAILS

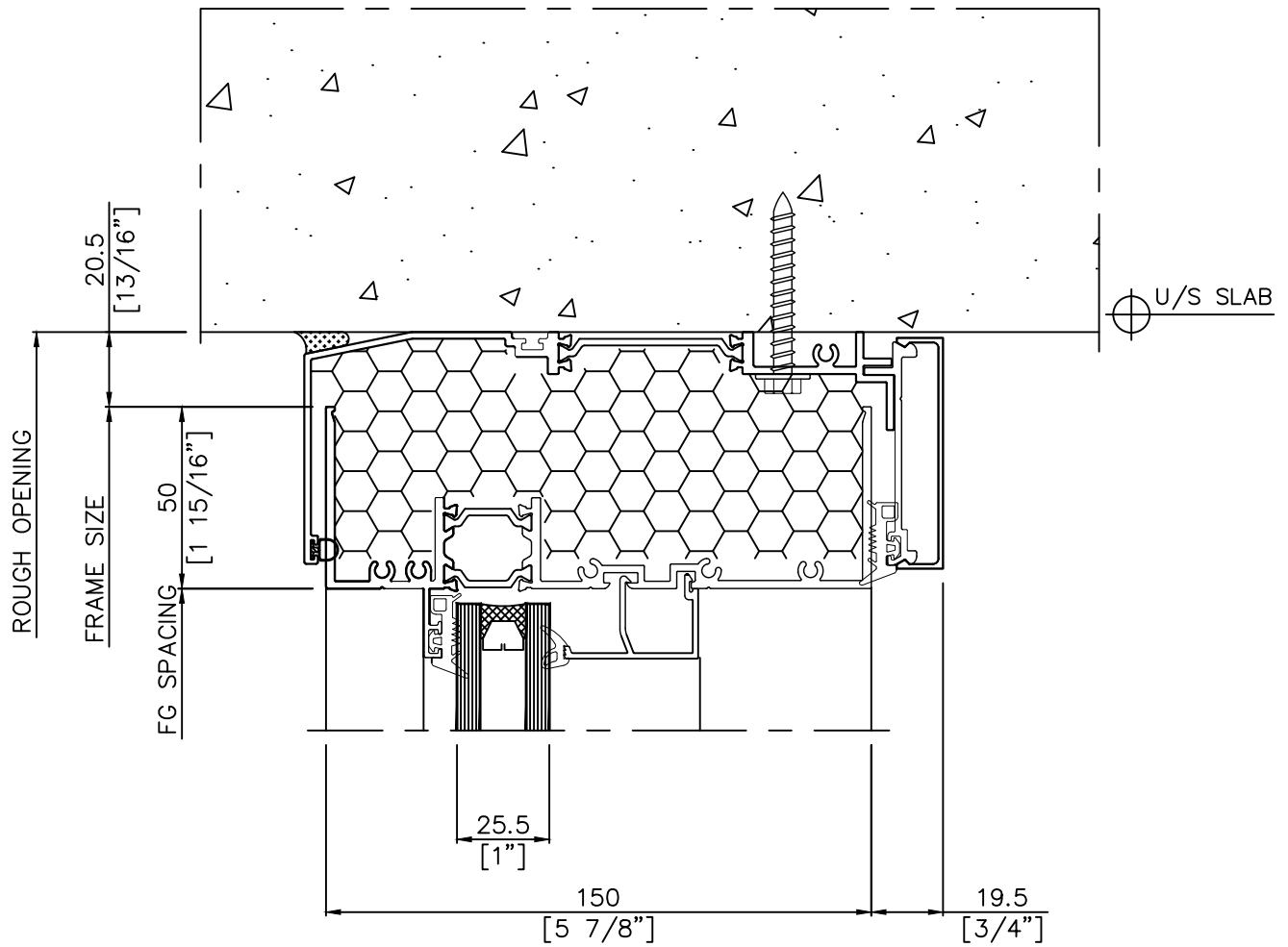

V7

1000 WINDOW WALL SERIES

TYPICAL DETAILS

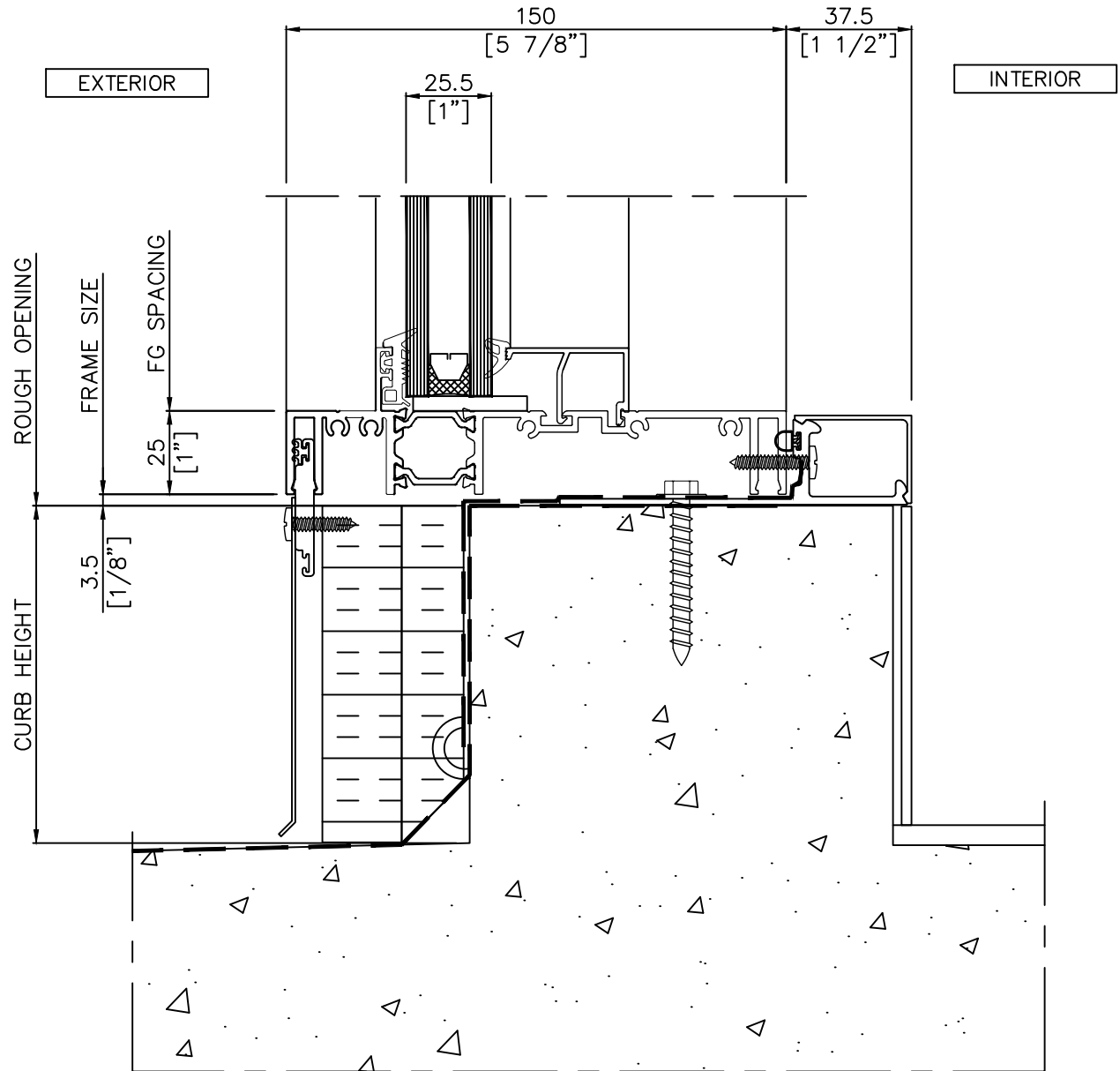

V8

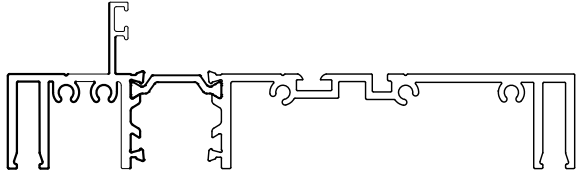
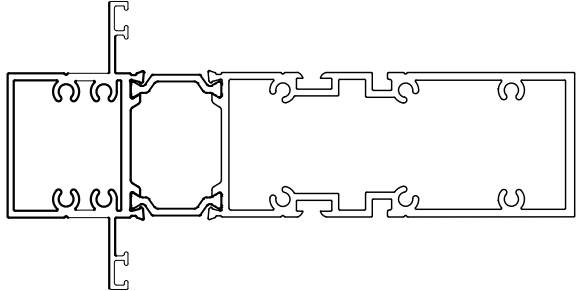
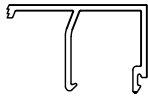
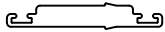
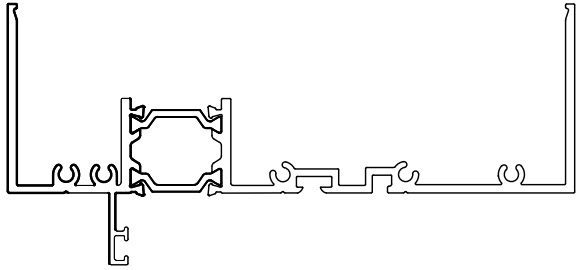

1000 WINDOW WALL SERIES

PARTS LIST

Part Number	Description	Profile
1000-01	1"x5 ⁷ / ₈ " (25mm x 150mm) Half Vertical Mullion or Sill horizontal	
1000-02	1 ¹ / ₂ "x5 ⁷ / ₈ " (38mm x 150mm) Horizontal	
1000-03	Snap-in Glass stop	
1000-04	Alignment Plate	
1000-05	2"x5 ⁷ / ₈ " (38mm x 150mm) Head Horizontal	

1000 WINDOW WALL SERIES

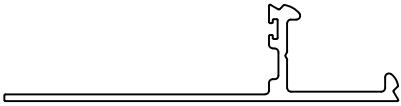
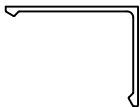
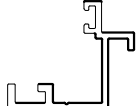

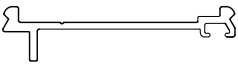
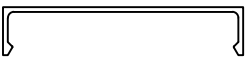

PARTS LIST

Part Number	Description	Profile
1000-06	Floor Bracket	
1000-07	Floor Bracket Cover	
1000-08	Spandrel Glass Holder	
1000-09	Spandrel Glass Stop	
1000-10	Top Frame Interior Adaptor	
1000-11	Top Frame Interior Cover	

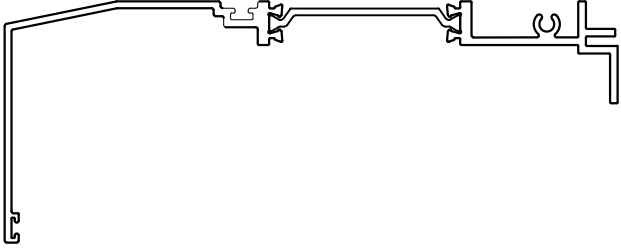
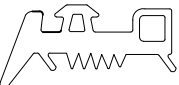

1000 WINDOW WALL SERIES

PARTS LIST

Part Number	Description	Profile
1000-12	Top Frame Exterior Adaptor	
1000-G201	Glazing Gasket	 <p style="text-align: right;">N.T.S.</p>
1000-G202	Glazing Gasket	 <p style="text-align: right;">N.T.S.</p>
1000-G203	Alignment Gasket	 <p style="text-align: right;">N.T.S.</p>
1000-G204	Glazing Gasket	 <p style="text-align: right;">N.T.S.</p>
1000-G205	6mm bubble foam Gasket	 <p style="text-align: right;">N.T.S.</p>